

目 录

一、运输作业组织与管理模块..... 2

二、仓储与配送作业组织与管理模块..... 34

三、国际物流作业组织与管理模块..... 150

四、 快递物流作业组织与管理模块.....	213
-----------------------	-----

湖南商务职业技术学院物流管理专业学生技能考核题库

一、运输作业组织与管理模块

○

○

○

--	--	--

○

○

--	--	--	--	--

() 任务描述

- :
-
-





<input type="checkbox"/> <input type="checkbox"/>				<input type="checkbox"/> <input type="checkbox"/>				
<input type="checkbox"/> <input type="checkbox"/>								
						<input type="checkbox"/> <input type="checkbox"/> <input type="checkbox"/> <input type="checkbox"/>		



() 任务描述:

-
-
-

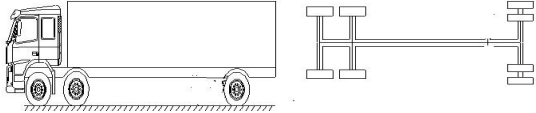

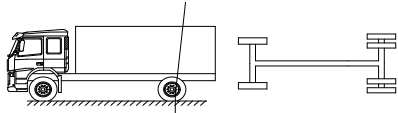
○

○

○

--	--	--	--	--

() 任务描述:

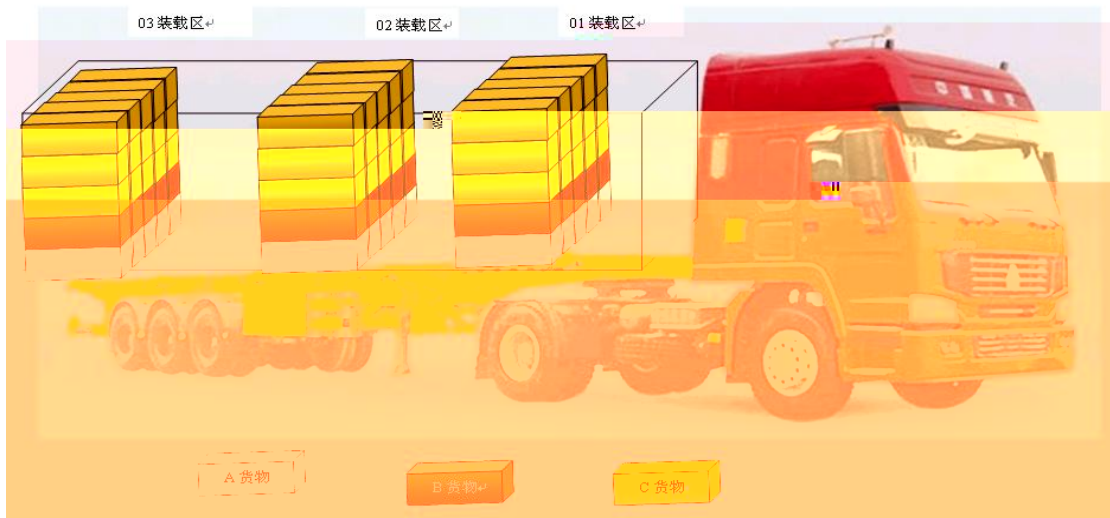

○

○

○

○

○

() 任务描述



D

<input type="checkbox"/> <input type="checkbox"/>			<input type="checkbox"/> <input type="checkbox"/>						
<input type="checkbox"/> <input type="checkbox"/>									
						<input type="checkbox"/> <input type="checkbox"/> <input type="checkbox"/> <input type="checkbox"/>			





2

3

4

() 任务描述

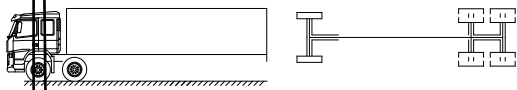
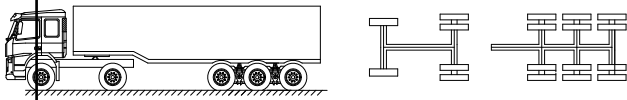
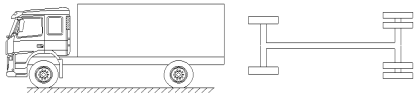
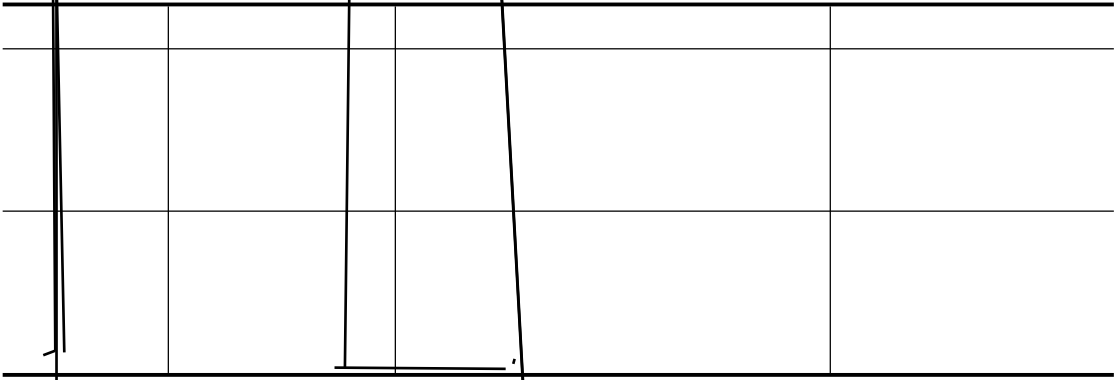



() 任务描述

-
-
-
-
-

() 任务描述

()

()

)	()		

()

()

()

()

()

○

()		

Sailing Schedule from : Shenzhen,Shenzhen,Guangdong,China

To : Los Angeles,Los Angeles,CA,United States

Origin City : Shenzhen,Shenzhen,Guangdong,China

Destination City : Los Angeles,Los Angeles,CA,United States

CY/DOOR

CY/DOOR

序列号	航线	船名	航次	截关时间	装货港	预计离港时间	实际离港时间	卸货港
1	YPSW	YM UNISON	59E	2016-04-22 17:00	Yantian	2016-04-25		Los Angeles
2	SEA	NORTHERN JAVELIN	002E	2016-04-23 12:00	Yantian	2016-04-27		Long Beach
3	AAS2	CMA CGM LIBRA	095TXE	2016-04-25 16:00	Yantian	2016-04-28		Long Beach
4	YPSW	YM UBIQUITY	22E	2016-04-29 17:00	Yantian	2016-05-02		Los Angeles
5	SEA	C SCL PUSAN	117E	2016-04-30 12:00	Yantian	2016-05-04		Long Beach
6	AAS2	CMA CGM COLUMBA	097TXE	2016-05-02 16:00	Yantian	2016-05-05		Long Beach
7	SEA	COSCO NINGBO	069W	2016-05-06 11:00	Yantian	2016-05-08		Long Beach
8	YPSW	YM UBERTY	50E	2016-05-06 17:00	Yantian	2016-05-09		Los Angeles ¹
9	SEA	COSCO EXCELLENCE	027E	2016-05-07 12:00	Yantian	2016-05-11		Long Beach
10	AAS2	CMA CGM CENTAURUS	099TXE	2016-05-09 16:00	Yantian	2016-05-12		Long Beach
11	YPSW	YM MASCULINITY	32E	2016-05-13 17:00	Yantian	2016-05-16		Los Angeles
12	SEA	HONG KONG BRIDGE	039E	2016-05-14 12:00	Yantian	2016-05-18		Long Beach
13	AAS2	CMA CGM THALASSA	101TXE	2016-05-16 16:00	Yantian	2016-05-19		Long Beach



干货箱



	箱体内部尺寸			箱体内容积及载重量		箱门开度尺寸	
	L	W	H	Cu	P	W	H
20'	5898	2352	2393	33.2	21740/28230#	2340	2280
40'	12032	2352	2393	67.7	26630	2340	2280
HC	12032	2352	2698	76.3	26520	2340	2585

冷藏箱



	箱体内部尺寸			箱体内容积及载重量	
	L	W	H	Cu	P
20'	5444	2284	2267	28.5	21135/27160#
40'	11583	2284	2250	58.7	26580
HC	11583	2284	2556	67.9	26380

开顶箱



	箱体内部尺寸			箱体内容积及载重量	
	L	W	P	Cu	P
20'	5900	2330	2337	32.6	21740
40'	12025	2330	2337	65.8	26410

○

○

() 实施条件

() 考核时量

() 评分细则

1

() 任务描述



		<input type="checkbox"/>	<input type="checkbox"/>	<input type="checkbox"/>	<input type="checkbox"/>

<input type="checkbox"/>	<input type="checkbox"/>				
<input type="checkbox"/>	<input type="checkbox"/>				



() 实施条件

() 考核时量

() 评分细则

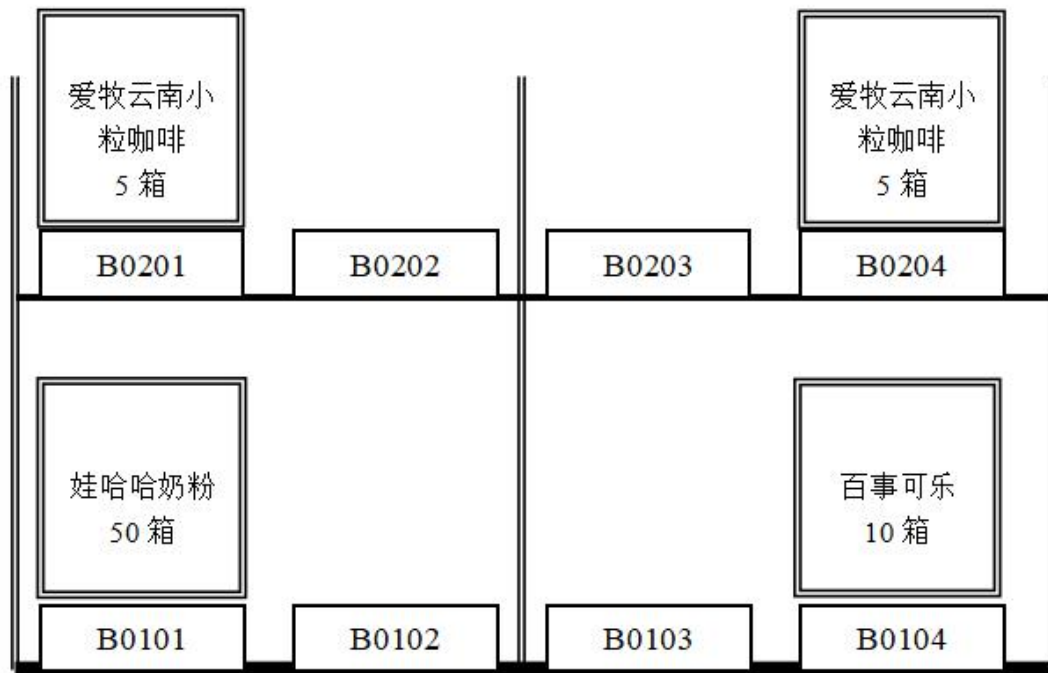
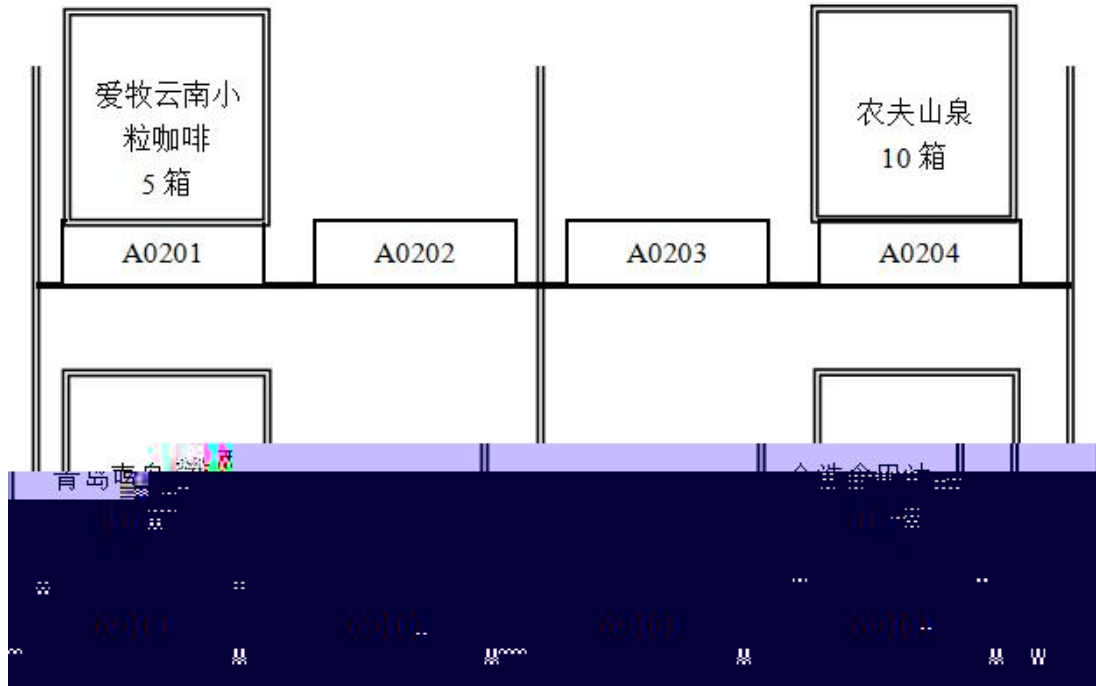

产品运输单

-
-
-
-
-
-
-
-

80				

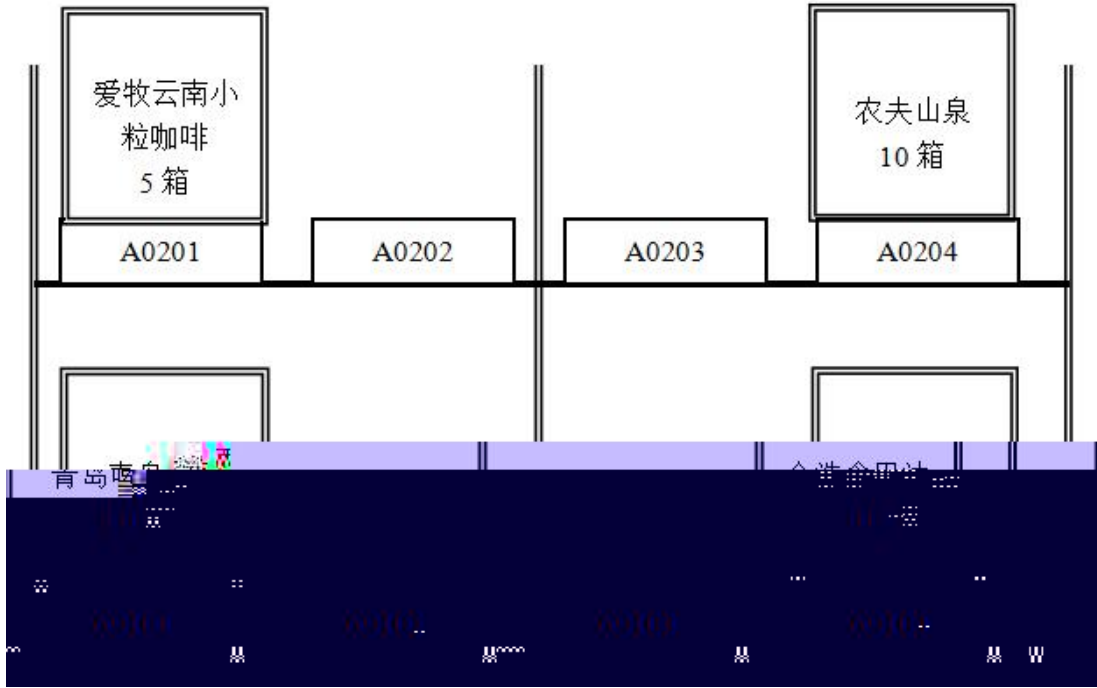

产品运输单

-
-
-
-
-
-
-
-

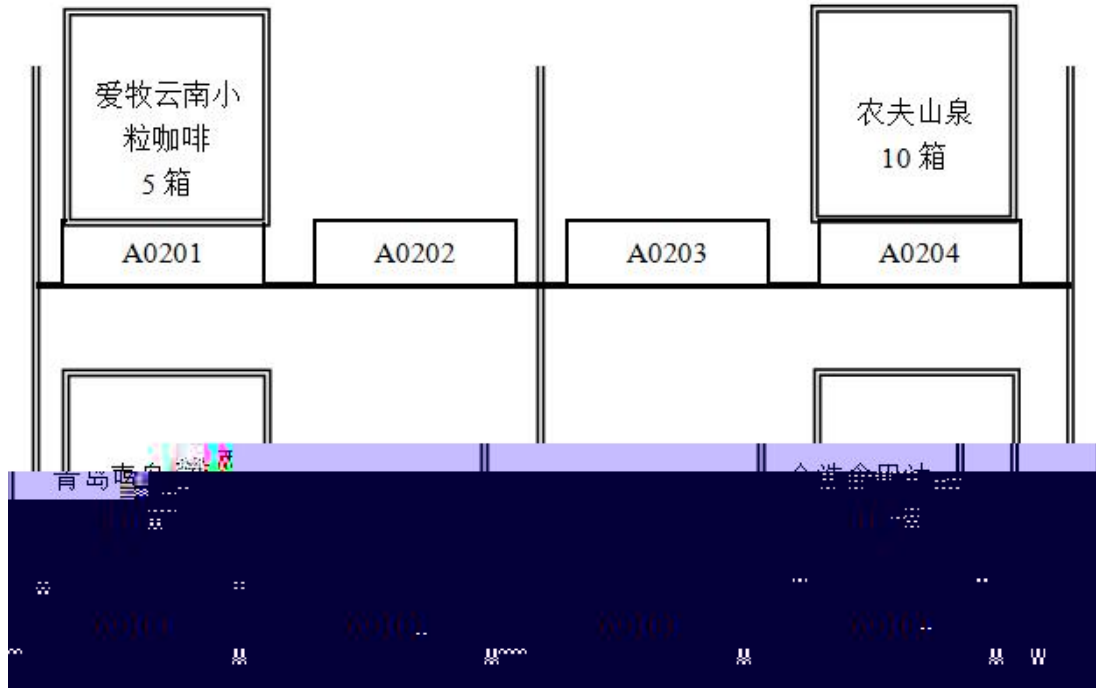

产品运输单

-
-
-
-
-
-
-
-

●●
●●
●●
●●
●●
●●
●●
●●

●●
●●
●●
●●
●●
●●
●●
●●

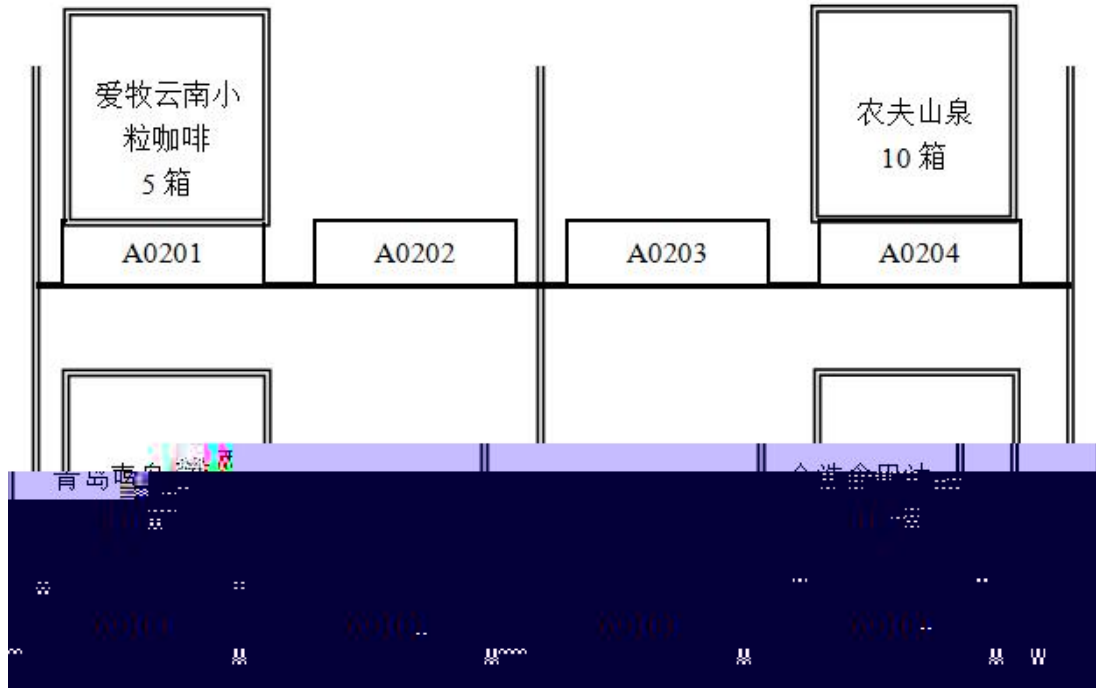

产品运输单

-
-
-
-
-
-
-
-

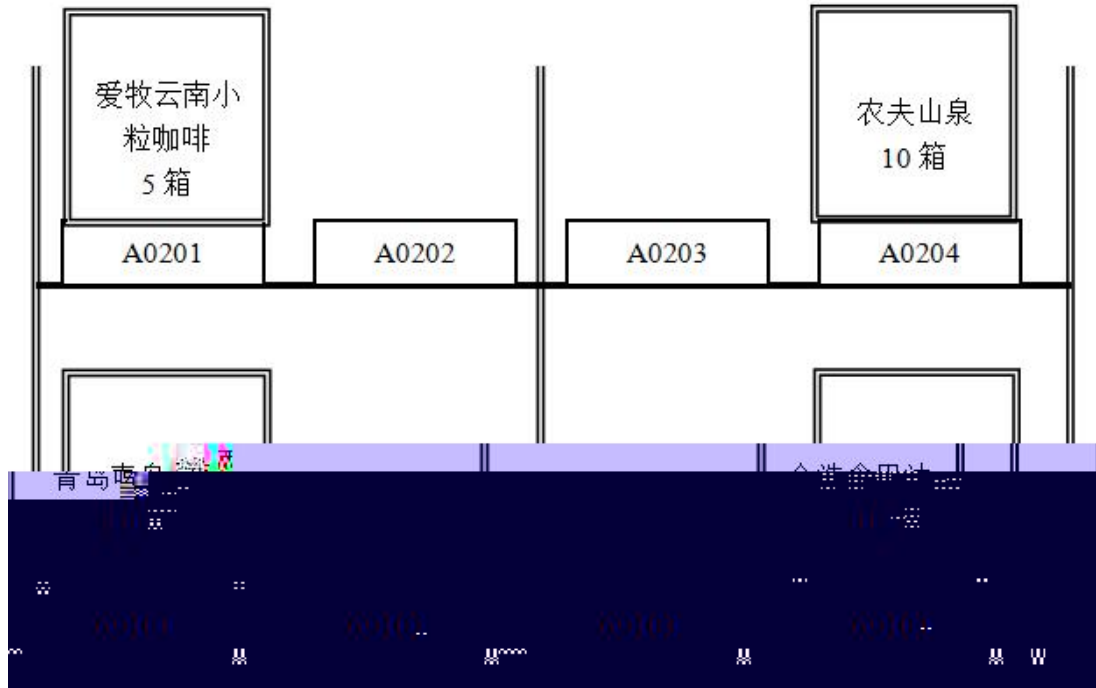

产品运输单

○

○

○

○

○

X , 'i

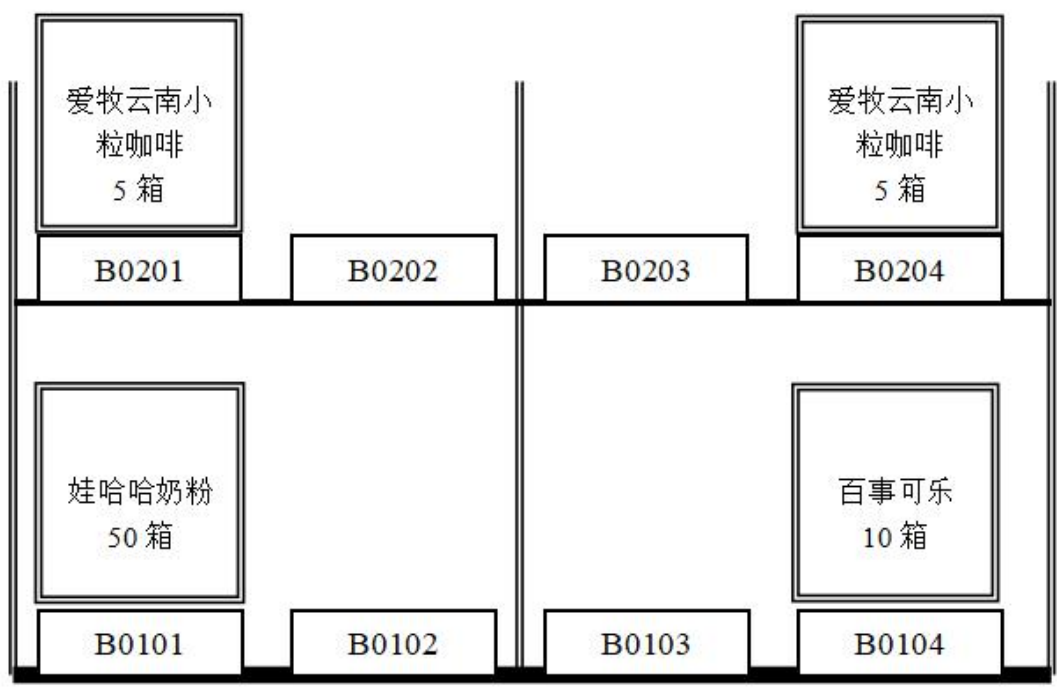
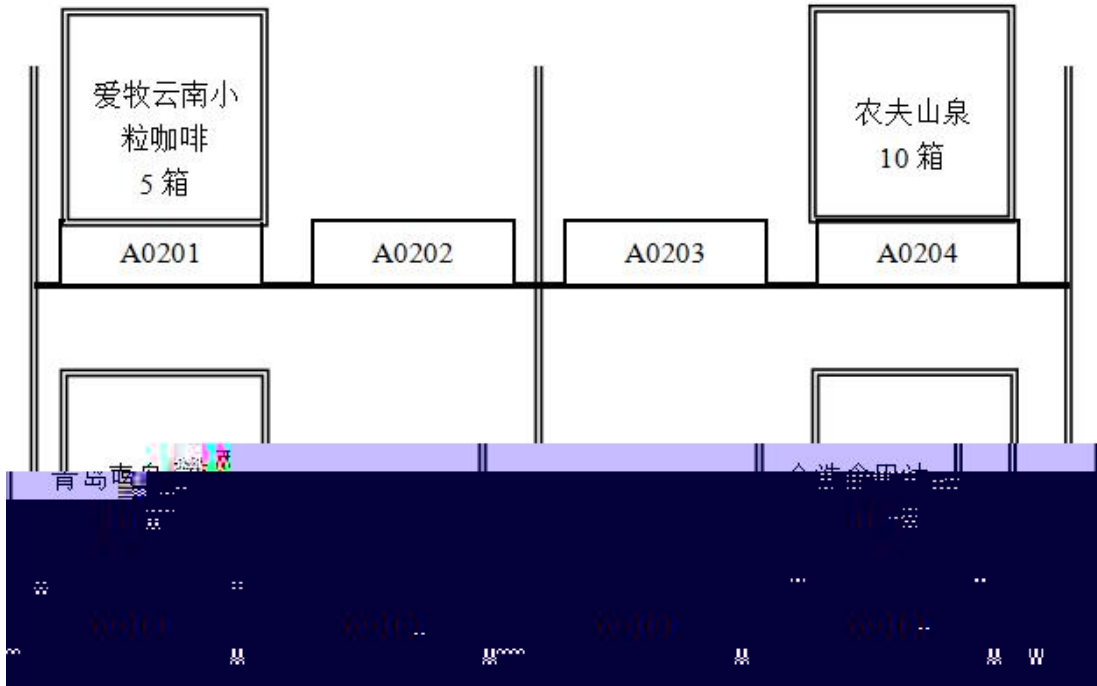

产品运输单

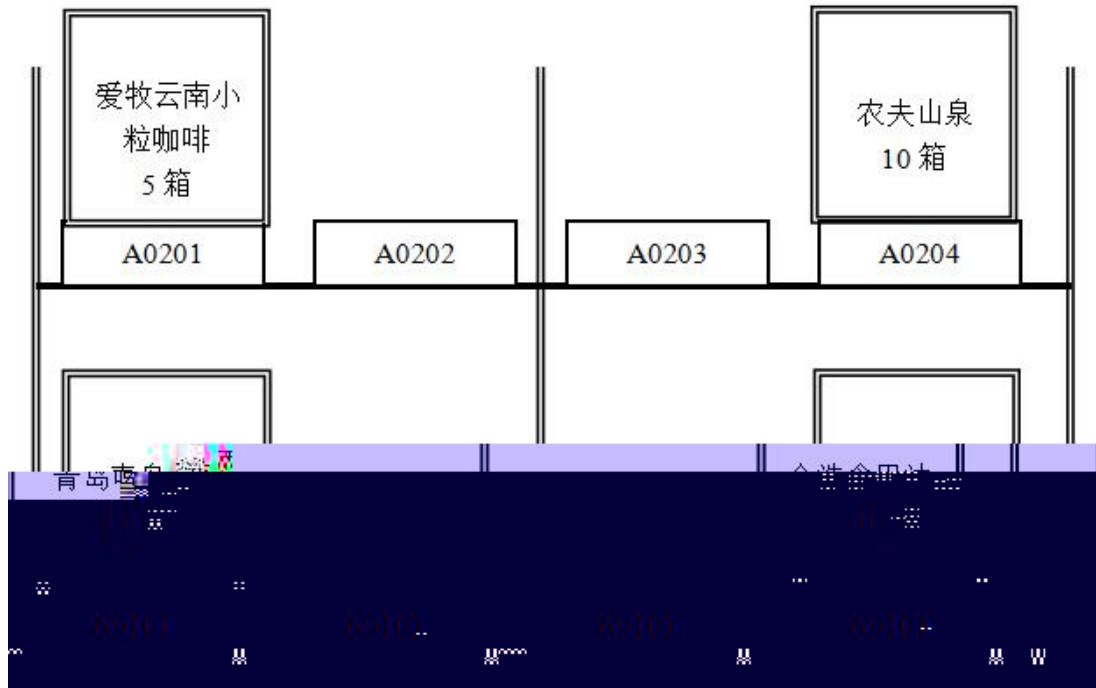

产品运输单

-
-
-
-
-
-
-
-
-

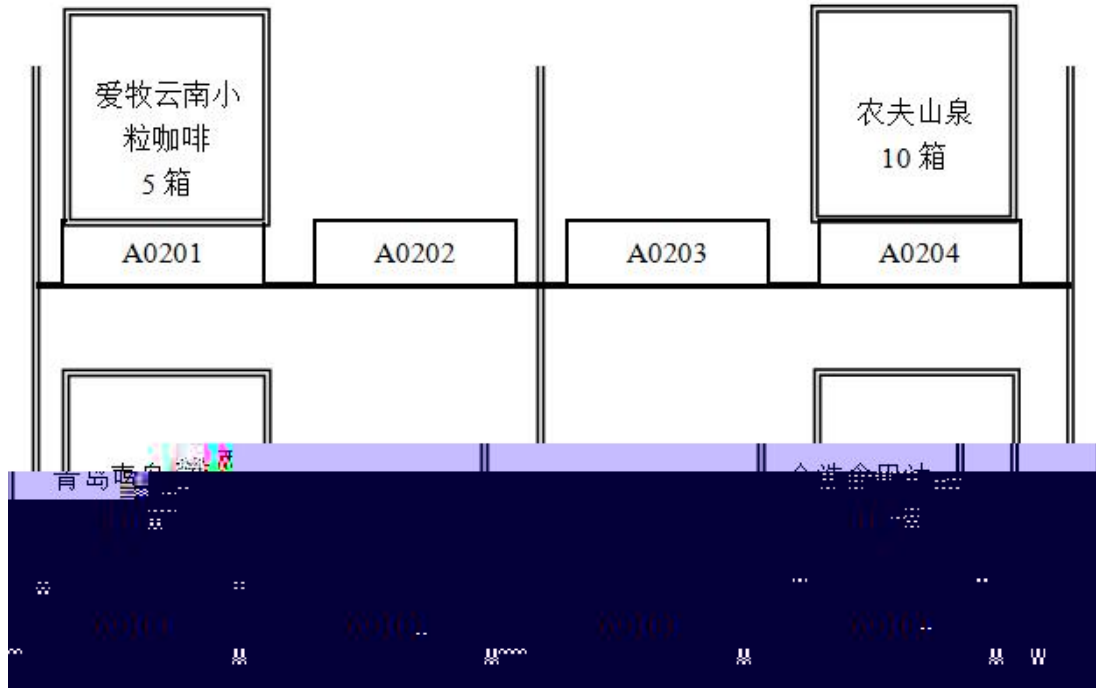

产品运输单

-
-
-
-
-
-
-
-

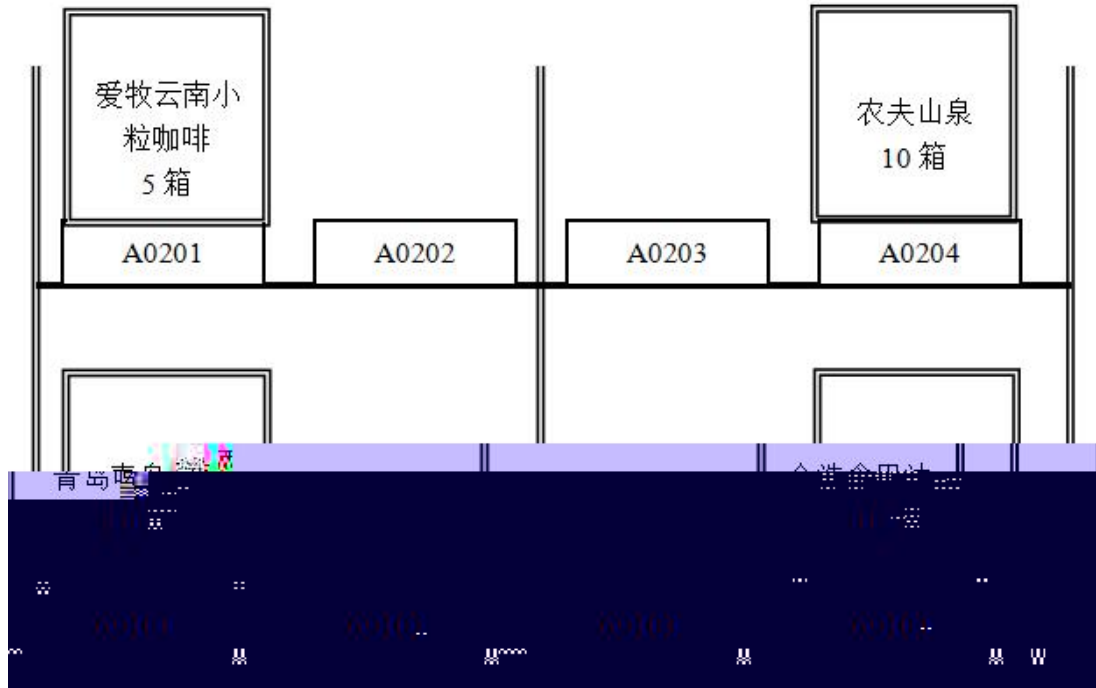

产品运输单

-
-
-
-
-
-
-
-

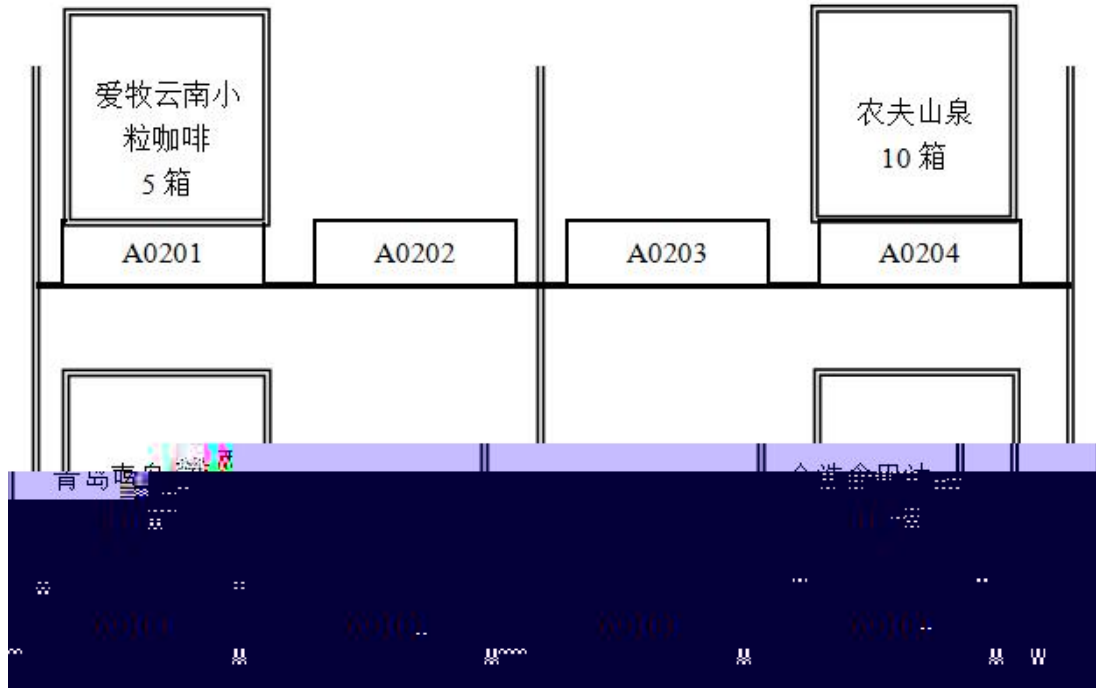

产品运输单

-
-
-
-
-
-
-
-

○

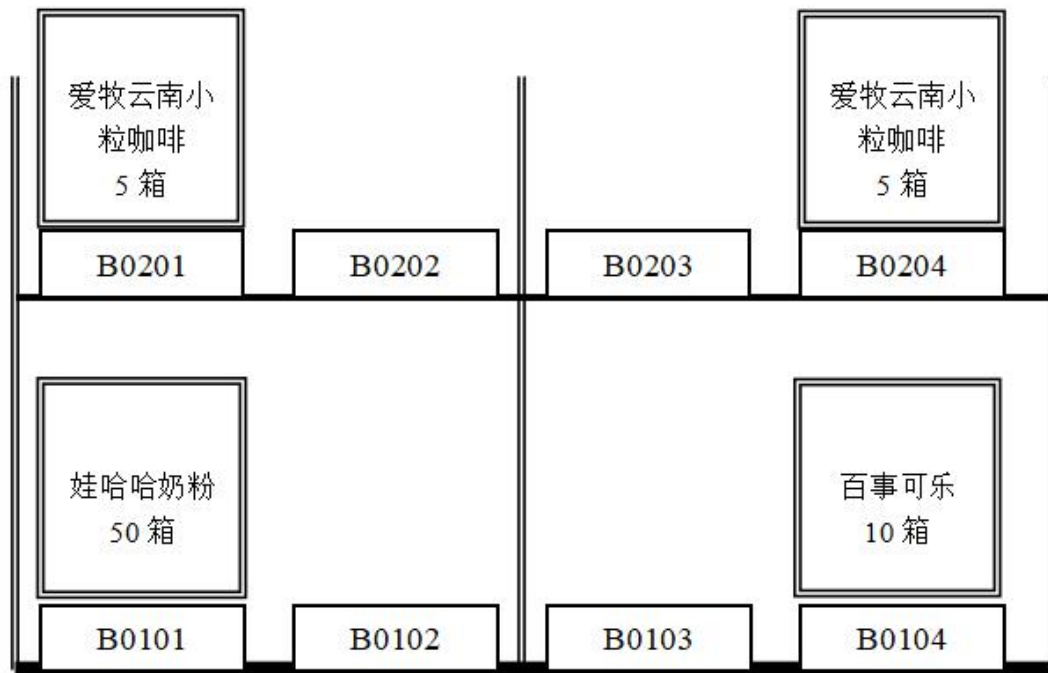
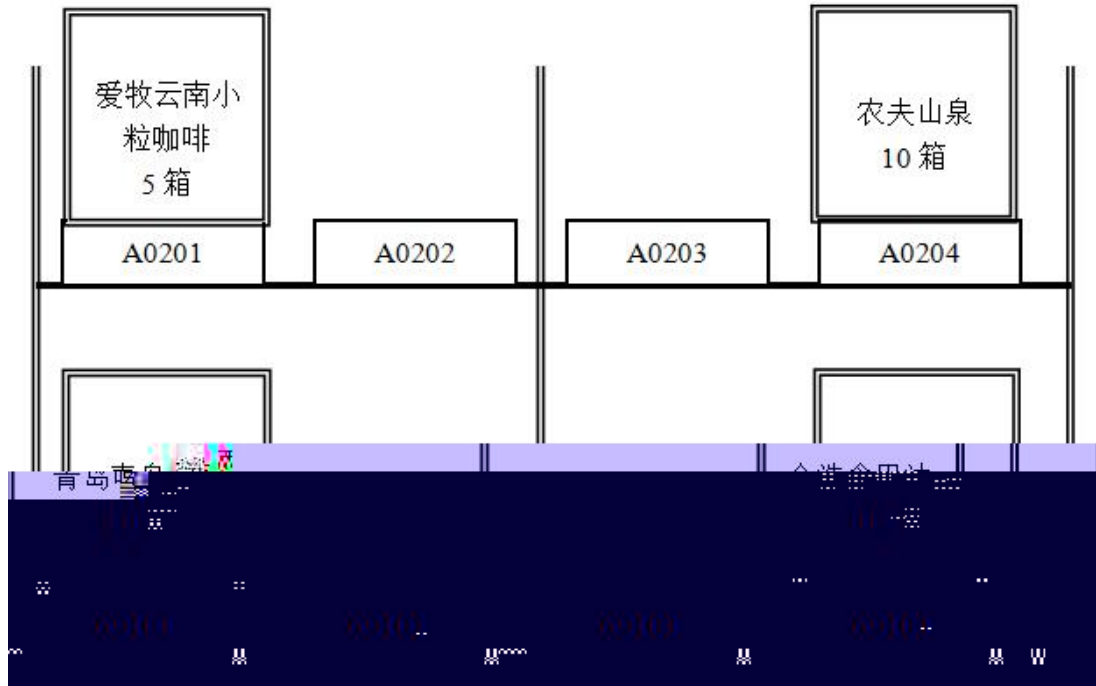



--	--	--	--	--	--

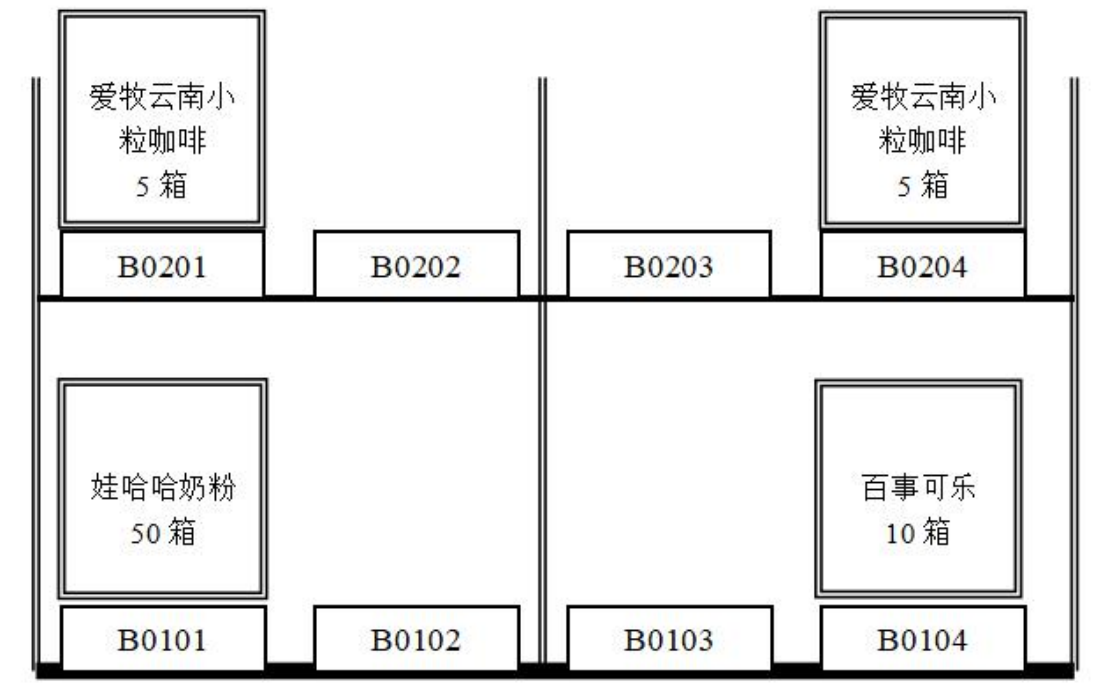
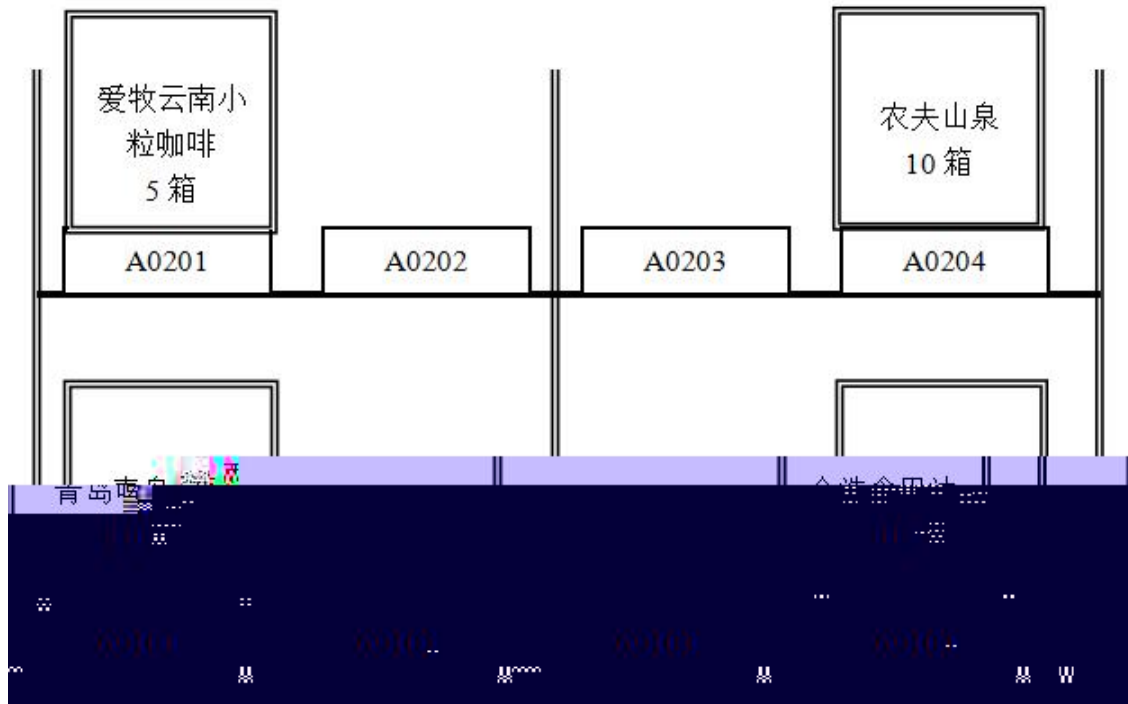

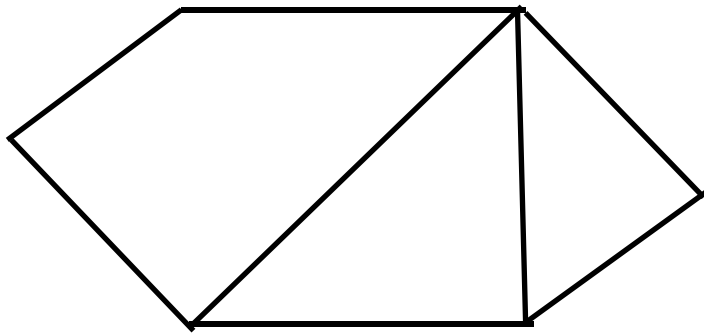

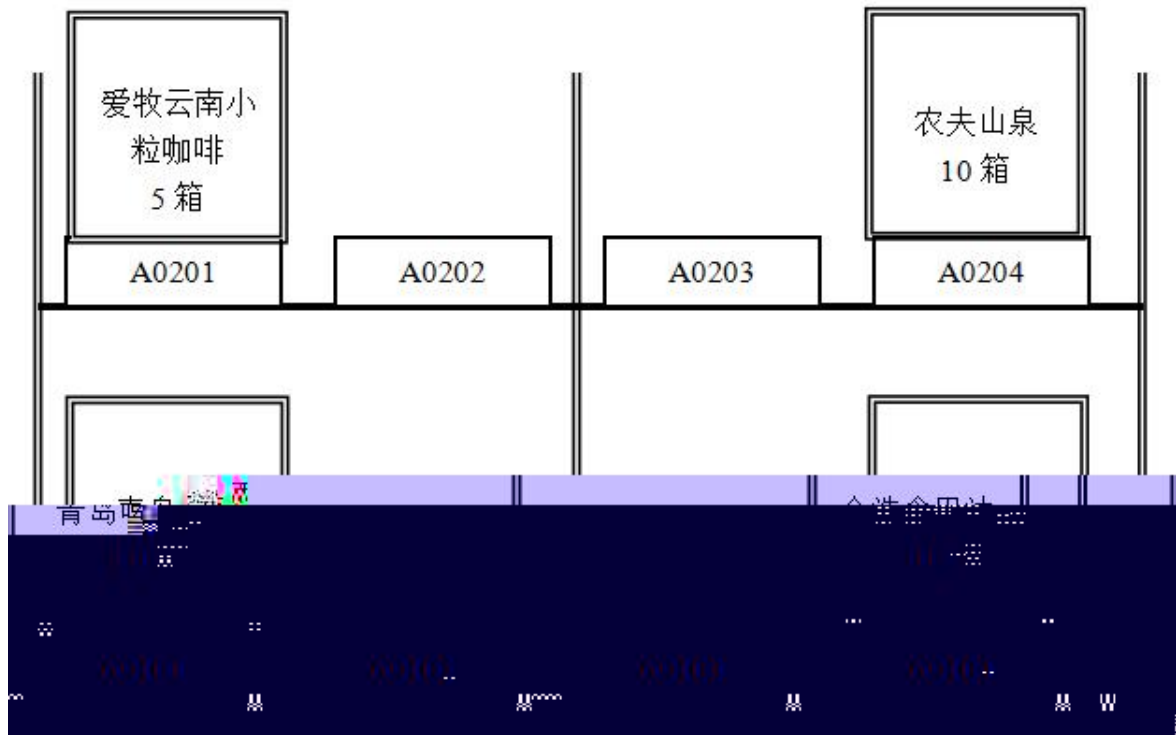



1

		---	---		

		---	---		

--	--

--- ---

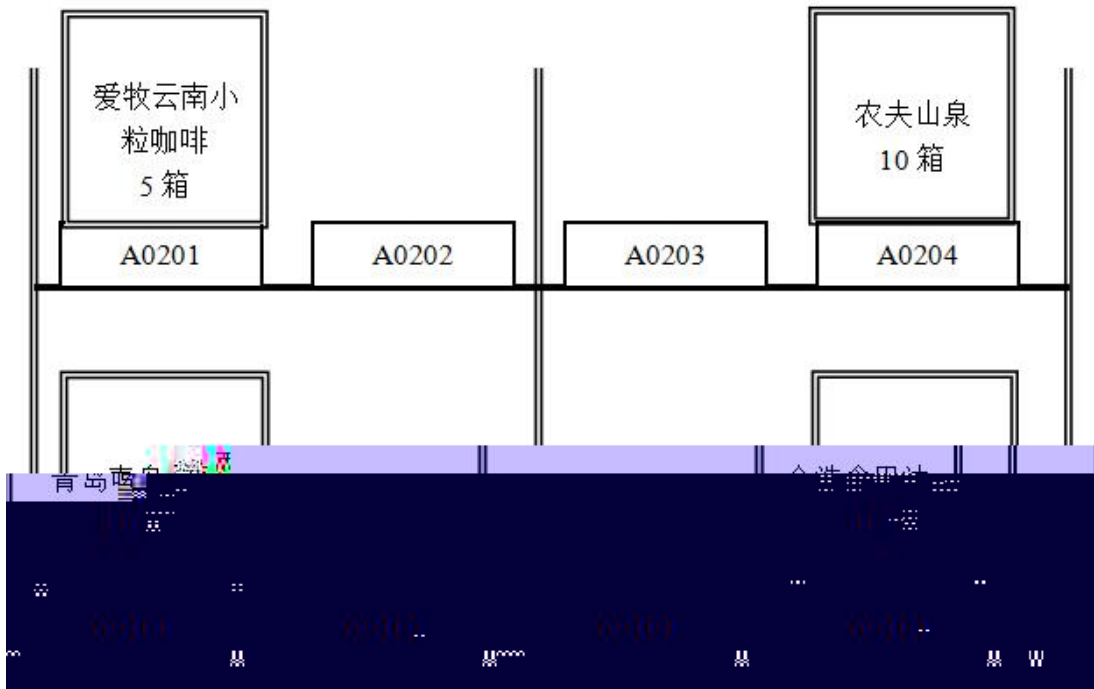

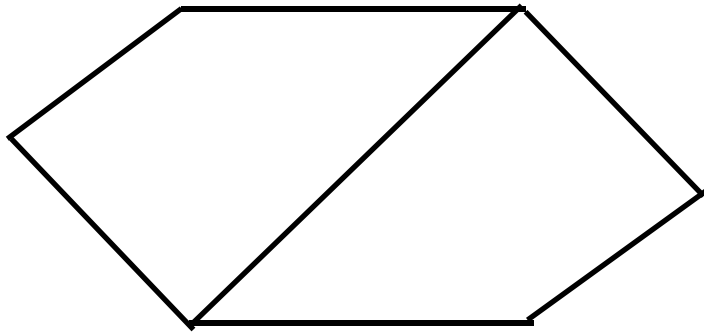

1

--	--	--	--	--	--

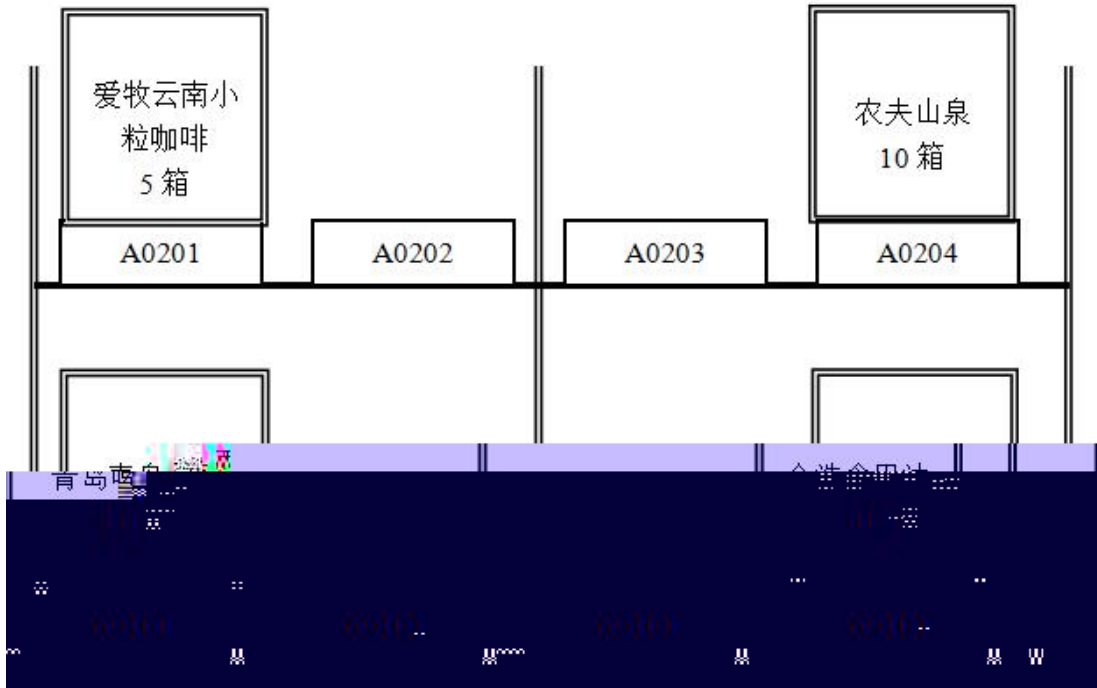



○

○

○

○

○

○

○

○

--	--

○

○

三、国际物流作业组织与管理模块

○



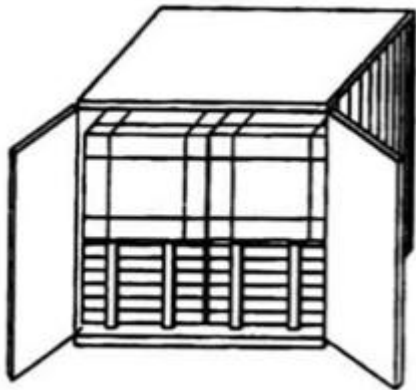
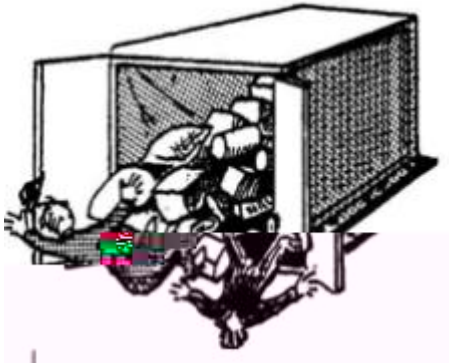
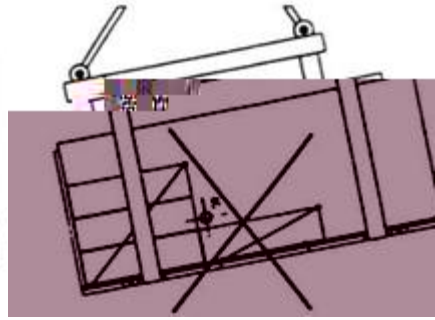

○

船公司 Carrier	船名/航次 Ship/Service	服务代码 Service Code	航线 Route	装船港/卸船港 Load/Discharge Port	启-达日期 ETD/ETA	天 Days	挂港 Ports
招商局	招商局 001		香港-上海	香港-上海-香港	08-01	1	香港
招商局	招商局 002		香港-上海	香港-上海-香港	08-02	1	香港
招商局	招商局 003		香港-上海	香港-上海-香港	08-03	1	香港
招商局	招商局 004		香港-上海	香港-上海-香港	08-04	1	香港
招商局	招商局 005		香港-上海	香港-上海-香港	08-05	1	香港
招商局	招商局 006		香港-上海	香港-上海-香港	08-06	1	香港
招商局	招商局 007		香港-上海	香港-上海-香港	08-07	1	香港
招商局	招商局 008		香港-上海	香港-上海-香港	08-08	1	香港
招商局	招商局 009		香港-上海	香港-上海-香港	08-09	1	香港
招商局	招商局 010		香港-上海	香港-上海-香港	08-10	1	香港

○
○

BEIJING	CN		BJ\$
Y. RENMINBI	CNY		KGS
BOSTON	1000000	1000000	1000000
		1000000	1000000
		1000000	1000000
		1000000	1000000
		1000000	1000000

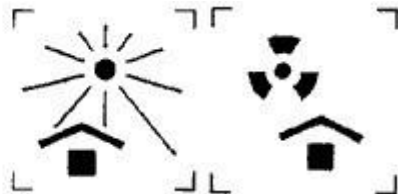

○

○

○

集装箱设备交接单
EQUIPMENT INTERCHANGE RECEIPT

OUT 出场

用箱人/运箱人(CNTR. USER/HAULIER)		提箱地点(PLACE OF DELIVERY)	
发往地点(DELIVERED TO)		返回/收箱地点(PLACE OF RETURN)	
船名/航次(VESSEL/VOYAGE No.)	集装箱号(CNTR. No.)	尺寸/类型(SIZE/TYPE)	承运人(CNTR. OPTR)
箱号(No.)	箱号(No.)	箱封号(SEAL No.)	免费期限(FREE TIME PERIOD)
货重(CARGO W.)	出场目的/状态(PPS OF GATE-OUT/STATUS)	进场目的/状态(PPS OF GATE-IN/STATUS)	出场日期(TIME-OUT) 月 日 时
出场检查记录(INSPECTION AT THE TIME OF INTERCHANGE)			
普通集装箱(GP. CNTR.)	冷藏集装箱(RC. CNTR.)	特种集装箱(SEL. CNTR.)	发电机(GEN. SET)
<input type="checkbox"/> 正常(SOUND) <input type="checkbox"/> 异常(DEFFECTIVE)	<input type="checkbox"/> 正常(SOUND) <input type="checkbox"/> 异常(DEFFECTIVE)	设定温度(SET) 记录温度(RECORDED)	<input type="checkbox"/> 正常(SOUND) <input type="checkbox"/> 异常(DEFFECTIVE)
损坏记录及代号(DAMAGE CODE)			
除列明者外, 集装箱设备交接单时完好无损, 密封完整无损。 EQUIPMENT INTERCHANGED IN SOUND CONDITION AND SEAL INTACT UNLESS OTHERWISE STATED 用户/承运人签字 (USER'S SIGNATURE)			
码头/堆场值班员签字 (TERMINAL/DEPOT CLERK'S SIGNATURE)			
年 月 日 年 月 日 年 月 日			
集装箱用户/承运人 (CONTAINER USER/HAULIER)			



--	--	--	--	--	--

--	--	--

--	--	--	--	--	--

--	--	--	--	--	--

--	--	--	--	--	--	--	--

○

Äc,,TD))PS" U"PQT 0c,,TD P 4ÿ

○

--	--	--

--	--	--	--	--	--

○

○

○

○

四、 快递物流作业组织与管理模块

--	--	--	--	--	--

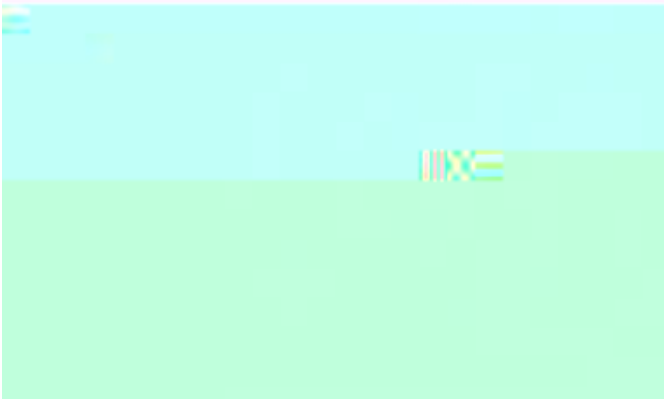
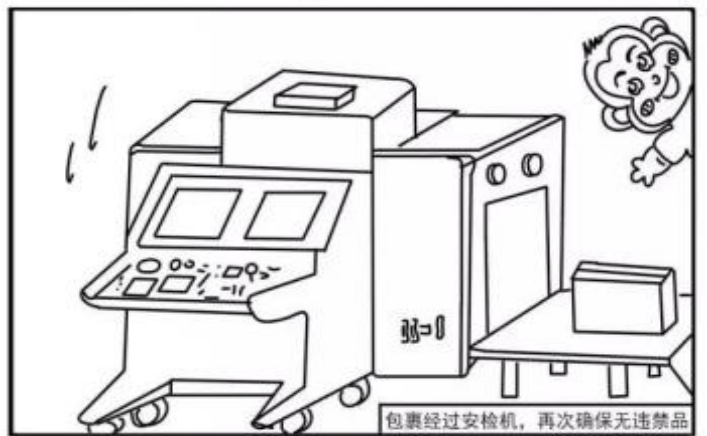

--	--	--	--	--	--

--	--	--	--	--	--

[想知道:中国成都理工大学校园快递具体在哪? 百度知道](#)

3个回答 - 提问时间: 2014年02月10日

最佳答案:韵达在银杏后面。宝盒、圆通、顺丰在电影院后面。中通、申通在图书馆下面。常用的是这几个。

[zhidao.baidu.com/link?... 2014-02-15](#) - 百度快照 - 80%好评

--	--	--	--

--	--	--	--

» VR y&c#000ay#65.#f c 0%". 10#S, 63 58A1# #S, 50%". 4ER

8

!



<hr/>
